

Intel[®]
SIU520 Signalling Interface Unit
SG430 Signalling Gateway
Hardware User Manual

Document Reference: U05SIU0B

Revision History

ISSUE	DATE	CHANGES
A	08-Apr-02	Initial release of manual for review.
B	12-Apr-02	Inclusion of review comments. Released for Regulatory approvals.

Disclaimer

The server may contain design defects or errors known as errata which may cause the product to deviate from published specifications.

Information in this document is provided in connection with Intel® products. No license, express or implied, by estoppel or otherwise, to any intellectual property rights is granted by this document. Except as provided in Intel's Terms and Conditions of Sale for such products, Intel assumes no liability whatsoever, and Intel disclaims any express or implied warranty, relating to sale and/or use of Intel products including liability or warranties relating to fitness for a particular purpose, merchantability, or infringement of any patent, copyright or other intellectual property right. Intel products are not designed, intended or authorized for use in any medical, life saving, or life sustaining applications or for any other application in which the failure of the Intel product could create a situation where personal injury or death may occur. Intel may make changes to specifications and product descriptions at any time, without notice.

This equipment has been tested and found to comply with the limits for a Class A digital device, pursuant to part 15 of the FCC Rules. These limits are designed to provide reasonable protection against harmful interference when the equipment is operated in a commercial environment. This equipment generates, uses, and can radiate radio frequency energy and, if not installed and used in accordance with the instruction manual, may cause harmful interference to radio communications. Operation of this equipment in a residential area is likely to cause harmful interference in which case the user will be required to correct the interference at his own expense.

Intel and Pentium are registered trademarks of Intel Corporation or its subsidiaries in the United States and other countries.

† Other names and brands may be claimed as the property of others.

Copyright © 2002 Intel Corporation. All rights reserved. No part of this document may be copied, or reproduced in any form, or by any means without prior written consent of Intel.

Contents

Part I: User's Guide	5
1. Introduction	9
1.1 Purpose	9
1.2 Chassis	9
1.3 Power Supplies	9
1.4 Server Board	10
1.5 Cooling	10
1.6 Signalling Card	10
1.7 Related Documentation	10
1.8 Applicability	11
2. Specification	12
2.1 Power Supply (DC Version)	12
2.2 Power Supply (AC Version)	12
2.3 PCM Interface	12
2.4 SS7 Serial Ports	13
2.5 Signalling Interface	13
2.6 Serial Port	13
2.7 Alarm Outputs	13
2.8 Visual Indicators	14
2.9 Ethernet Interfaces	14
2.10 Physical Specifications	14
2.11 Environmental	15
2.12 Reliability	15
2.13 Regulatory Approvals	15
3. Hardware description	16
3.1 Overview	16
3.2 Front Panel	17
3.3 Back Panel	19
4. Interfaces	20
4.1 Alarms	20
4.2 DC Power Input	21
4.3 Serial Ports	22
4.4 PCM Interface Ports	23
4.5 SS7 Serial Interface Ports	23
Part II: Service Technician's Guide	26
5. Maintenance	29
5.1 Tools and Supplies Needed	29
5.2 Cautions	29
5.3 Replacing Power Supply Modules	30
5.4 Working Inside the System	31
5.4.1 Safety: Before You Remove Server Covers	31
5.4.2 Warnings and Cautions	31
5.4.3 Removing and Installing the Top Cover	33

5.4.4	Internal Chassis Layout	34
5.4.5	Signalling Card Configuration	35
5.4.6	Signalling Card Installation	36
5.4.7	Replacing the Back Up Battery	38
A.	Warnings	40
A.1	WARNING: English.....	41
A.2	AVERTISSEMENTS : Français.....	43
A.3	WARNUNG: Deutsch.....	45
A.4	AVVERTENZA: Italiano.....	47
A.5	ADVERTENCIA: Español.....	49
B.	Electromagnetic Compatibility.....	51
B.1	USA and Canada Specific.....	51
B.2	Installation of Signalling Cards.....	51
C.	List of Part Numbers	52
Figures		
Figure 3-1.	SIU520/SG430 Chassis.....	16
Figure 3-2.	Front Panel.....	17
Figure 3-3.	Front View with Bezel Removed.....	18
Figure 3-4.	Back Panel DC Version, AC Version Shown at Right.....	19
Figure 4-1.	15-pin Alarms Connector	20
Figure 4-2.	DC Power Input Connector.....	21
Figure 4-3.	DC Power Terminal Lug	21
Figure 4-4.	Serial Ports A and B	22
Figure 4-5.	Signalling Card Connector Positions.....	23
Figure 5-1.	Tools and Supplies Needed.....	29
Figure 5-2.	Unlocking and Removing the Power Supply Modules.....	30
Figure 5-3.	Removing the Top Cover.....	33
Figure 5-4.	Internal Chassis Layout	34
Figure 5-5.	Signalling Card with 2 PCM ports and V.11 serial interface board.	35
Figure 5-6.	PCI Retainer Bracket Location.....	36
Figure 5-7.	Signalling Card Installation	37
Figure 5-8.	Replacing the Backup Battery.....	39
Tables		
Table 3-1.	Front Panel Features	17
Table 3-2.	Back Panel Features	19
Table 4-1.	Alarms Connector Pinout.....	20
Table 4-2.	Serial Port Connector pin-out.....	22
Table 4-3.	9-way DB9 Serial Cable pin-out.....	22
Table 4-4.	Balanced line interface connector pin-out	23
Table 4-5.	V.11 Serial interface connector pin-out	24
Table 4-6.	15-way Male D-Connector Serial Port Breakout Cable.....	25
Table 5-1.	Signalling Card Address Switch Settings	35
Table C-1.	Part Number Table.....	52

Part I: User's Guide

- 1 Introduction
- 2 Specification
- 3 Hardware description
- 4 Interfaces

This document provides an overview of the SIU520 and SG430 products. This manual consists of two parts:

- *User's Guide*, beginning on page 5 describes procedures that **DO NOT REQUIRE** removing and replacing boards. You do not need to be a qualified service technician to perform procedures listed in the *User's Guide*.
- *Service Technician's Guide*, beginning on page 26 describes procedures that **REQUIRE** removing and replacing boards. You must be a qualified service technician to perform procedures listed in the *Service Technician's Guide*.



WARNING

Only a QUALIFIED SERVICE TECHNICIAN is authorized to remove the server covers and to access any of the components inside the server. Before removing the covers, see “Safety: Before You Remove Server Covers” on page 31 and “Warnings and Cautions” on page 31.



WARNING

Anchor the equipment rack: The equipment rack must be anchored to an unmovable support to prevent it from falling over when one or more servers are extended in front of the rack on slides. You must also consider the weight of any other device installed in the rack. A crush hazard exists should the rack tilt forward which could cause serious injury.

Only use a screwdriver tip to push in the lock tabs on the rack slides. A pinch hazard exists if fingers are used for this purpose.

If AC power supplies are installed:

Mains AC power disconnect: The AC power cord(s) is considered the mains disconnect for the server and must be readily accessible when installed. If the individual server power cord(s) will not be readily accessible for disconnection then you are responsible for installing an AC power disconnect for the entire rack unit. This main disconnect must be readily accessible, and it must be labelled as controlling power to the entire rack, not just to the server(s). To remove all power, two AC cords must be removed.

Grounding the rack installation: To avoid the potential for an electrical shock hazard, you must include a third wire safety ground conductor with the rack installation. If the server power cord is plugged into an AC outlet that is part of the rack, then you must provide proper grounding for the rack itself. If the server power cord is plugged into a wall AC outlet, the safety ground conductor in the power cord provides proper grounding only for the server. You must provide additional, proper grounding for the rack and other devices installed in it.

Overcurrent protection: The server is designed for an AC line voltage source with up to 20 amperes of overcurrent protection per cord feed. If the power system for the equipment rack is installed on a branch circuit with more than 20 amperes of protection, you must provide supplemental protection for the server. The overall current rating of a server configured with two power supplies is less than 4 amperes.

If DC power supplies are installed:

The DC source must be electrically isolated by double or reinforced insulation from any hazardous AC or DC source. The DC source must be capable of providing up to 300 W of continuous power per feed pair. Connection with a DC source should only be performed by trained service personnel.

Main DC power disconnect: You are responsible for installing a DC power disconnect for the entire rack unit. This mains disconnect must be readily accessible, and it must be labelled as controlling power to the entire unit, not just to the servers(s).

Grounding the rack installation: To avoid the potential for an electrical shock hazard, you must include a third wire safety ground conductor with the rack installation. The safety grounding conductor must be a minimum 14AWG connected to the earth ground stud on the rear of the server. The safety ground conductor should be connected to the chassis stud with a two hole crimp terminal with a maximum width of 0.25 inch. The nuts on the chassis studs should be installed with a 10 in/lbs torque. The safety ground conductor provides proper grounding only for the server. You must provide additional, proper grounding for the rack and other devices installed in it.

Overcurrent protection: Overcurrent protection circuit breakers must be provided as part of each host equipment rack and must be installed between the DC source and the server. The server is designed for a DC line voltage power source with up to 10 amperes of overcurrent protection per feed pair. If the DC power system for the equipment rack is installed with more than 10 amperes of protection, you must provide supplemental protection for the server. The overall current rating of a server configured with two power supplies is less than 7 amperes.

 **WARNING**

Do not attempt to modify or use an AC power cord that is not the exact type required. You must use a power cord that meets the following criteria:

Rating: For U.S./Canada cords must be UL Listed/CSA Certified type SJT, 18-3 AWG. For outside U.S./Canada cords must be flexible harmonized (<HAR>) or VDE certified cord with 3 x 0.75mm conductors rated 250 VAC.

Connector, wall outlet end: Cords must be terminated in grounding-type male plug designed for use in your region. The connector must have certification marks showing certification by an agency acceptable in your region and for U.S. must be rated 125% of overall current rating of the server.

Connector, server end: The connectors that plug into the AC receptacle on the server must be an IEC 320, sheet C19, type female connector.

Cord length and flexibility: Cords must be less than 4.5 meters (14.76 feet) long.

 **WARNING**

ANTI-STATIC HANDLING PROCEDURES: The SIU520 and SG430 contain Electrostatic Sensitive Devices (ESDs) which may be permanently damaged if incorrectly handled. If modules are removed from the chassis they must be handled in accordance with appropriate anti-static handling procedures. Refer to: *EN100015-1 Basic Specification: Protection of Electrostatic Sensitive Devices: Part 1 General Requirements* for further details.

 **WARNING**

AUSTRALIA AND NEW ZEALAND SPECIFIC: To comply with the relevant safety requirements in these countries, connection of this equipment **MUST** be via a Line Isolation Unit with a telecommunications compliance label.

 **WARNING**

USA AND CANADA SPECIFIC: To comply with the relevant safety requirements in these countries, connection of this equipment to the public network **MUST** be via a network terminating device. (i.e. the unit must **NOT** be directly connected to the external public line).

 **CAUTION**

Temperature: The temperature in which the server operates when installed in an equipment rack, must not go below 5 °C (41 °F) or rise

above 40 °C (104 °F). Extreme fluctuations in temperature can cause a variety of problems in your server.

Ventilation: The equipment rack must provide sufficient airflow to the front of the server to maintain proper cooling. The rack must also include ventilation sufficient to exhaust a maximum of 1023 BTU's per hour for the server. The rack selected and the ventilation provided must be suitable to the environment in which the server will be used.

1. Introduction

1.1 Purpose

This document is the User Manual for the SIU520/SG430 which addresses all the hardware aspects of these products. It should be read in conjunction with the *SIU520 Signalling Interface Unit Configuration Manual* [Ref. 1] and the *SG430 Signalling Gateway Configuration Manual* [Ref. 2] which give full details of operation including the user interface and a full description of all configuration parameters and commands.

This User Manual includes the specification of the products and a full functional description of all the internal hardware modules. It details all the interface connections including full pin-out details and provides full installation instructions. It details the maintenance procedures allowing the user to make module level replacements in the field and lists the part numbers for all spare parts. Users should refer first to Appendix A Warnings which details important Safety Information.

1.2 Chassis

The SIU520/SG430 chassis is a 2U high rack mounted server intended for mounting in a standard 600mm x 600mm rack (DIN 41494). It houses up to 2 plug in power supply modules, a server board (containing dual Intel® Pentium® III FCPGA processors), CDROM, Floppy Disk Drive, Hard Disk Drive, four cooling fans and up to three Signalling Cards.

1.3 Power Supplies

The SIU520, SG430 systems can be configured with either a 350 Watt AC-input power subsystem or a 350 Watt DC-input power subsystem. The power supply modules are located in the power supply cage, which is mounted towards the left rear of the chassis. Both the AC and DC-input power subsystems may contain up to two 350 W power supply modules and can be configured as follows:

- One 350 W power supply module installed (this is the factory standard setting). Units configured in this manner can supply a fully loaded system but do not support dual redundancy.
- Two 350 W power supply modules installed. Units configured in this manner are dual redundant in the event of a failure of any one power supply, operation of the system will be unaffected.

When the system is configured with two power supply modules, the hot-swap feature allows the user to replace a failed power supply module without interrupting system functionality.



CAUTION

The power supply modules used in the AC-input power subsystem cannot be used in the DC-input subsystem, and the power supply modules used

in the DC-input power subsystem cannot be used in the AC-input power subsystem.

1.4 Server Board

The chassis incorporates a server board supporting dual Intel Pentium III FCPGA processors which supports the fitting of up to three full length PCI Signalling cards mounted on a 5V PCI riser card.

1.5 Cooling

The system contains a fan array consisting of two 80 x 38mm fans and two 40 x 28mm fans to cool the system baseboard and other components. The fans are installed directly behind the drive tray and are located in front of the baseboard. Individual fan connectors are located on the system baseboard. A fan failure is indicated by one of the alarm LED's located on the front panel.

1.6 Signalling Card

The SIU520 and SG430 use an intelligent multi-port line interface card with on-board signalling processor for the processing of SS7 signalling links. This is a PCI form factor card and occupies one of three board positions in a 5V riser card mounted on the server board.

The Signalling Card supports two primary rate telecommunications interfaces, each being individually configured at run-time under software control to operate as an E1, T1 or J1 interface with selectable line code and frame format.

The on-board signalling processors allow up to four SS7 signalling links to be terminated. Signalling links may be presented either as a timeslot on an external PCM interface, or as a synchronous V.11 (V.35 compatible) serial interface. Signalling links can all operate at 64kb/s, 56kb/s or 48kb/s.

The Signalling Card supports configurable clock recovery priorities with automatic switching to a new clock source upon failure and automatic restoration upon recovery of the failed clock source.

1.7 Related Documentation

[1] SIU520 Configuration Manual

[2] SG430 Configuration Manual

1.8 Applicability

This manual applies to the following products:

SIU520A	Signalling Interface Unit (AC Power Supply)
SIU520D	Signalling Interface Unit (DC Power Supply)
SG430A	Signalling Gateway (AC Power Supply)
SG430D	Signalling Gateway (DC Power Supply)

2. Specification

2.1 Power Supply (DC Version)

Input topology:	Four-terminal DC input power connector for DC input power supply cage.
Connector type:	Screw barrier connectors to accept either bare wire termination or crimp forks.
Voltage:	-38VDC to -75VDC (nominal -48 to -60VDC)
Maximum input current:	13.5A (maximum input current is measured at the lowest input voltage that the power supply continues to operate. This is not to be used for determining agency input current markings).
Power:	TBD W fully equipped.

2.2 Power Supply (AC Version)

Input topology:	AC input power connectors for AC input power supply cage. The lower AC connector connects to the right hand power supply as viewed from the rear. The upper AC connector connects to the left hand power supply as viewed from the rear (note the use of a second power supply is optional).
Connector type:	IEC mains input socket.
Voltage	100-127 V _{rms} 200-240 V _{rms}
Frequency	47 – 63 Hz
Maximum continuous input current:	6.7 A @ 110VAC
Power	TBD W fully equipped.

2.3 PCM Interface

Ports:	2 ports per card, up to a total of 6
Data rate:	2048 kbit/s (E1) or 1544 kbit/s (T1/J1) user configurable for each individual port
Connector:	RJ45
Pulse shape:	ITU-T G.703, AT&T TR62411
Frame format:	E1, E1-CRC4, D4, ESF
Line code:	HDB3, AMI (ZCS), AMI, B8ZS

2.4 SS7 Serial Ports

Ports:	2 ports per card, up to a total of 6 - mounted on the rear of the chassis.
Data Rate:	48kbit/s, 56 kbit/s, 64 kbit/s or external
Connector:	26 pin High density D-type female shared between both ports
Electrical:	V.11 (V.35 compatible)
Signals:	Tx Clock, Rx Clock, Tx Data, Rx Data
Clocking:	Internal or External

2.5 Signalling Interface

Source:	PCM interface, H.100 or serial interface
Data Rate:	48kbit/s, 56 kbit/s, 64 kbit/s
Timeslot:	Fully programmable
Signalling links:	up to four SS7 signalling links to be terminated per signalling card.

2.6 Serial Port

Quantity:	One-mounted on the rear of the chassis.
Connector:	RJ45
Electrical:	RS 232
Signals:	TD, SGND, RD, DSR, DTR

2.7 Alarm Outputs

Type:	Each alarm (Major, Minor, Critical and Power) is the output of a STDT relay contact. A common contact with normally open and normally closed connections is provided. Power alarm has just a common and normally open contact outputs.
Designation:	Major, Minor, Critical and Power
Contacts:	Single, break before make changeover, voltage free
Contact rating:	60V DC (maximum)
Connector:	15-way D-type socket

2.8 Visual Indicators

Critical Alarm	Amber
Major Alarm	Amber
Minor Alarm	Amber
Power Alarm	Amber
NIC activity LED	Green - Indicates NIC activity.
HDD activity LED	Green - Indicates any system hard drive activity.
Main power LED	Green - When continuously lit, indicates the presence of DC power in the server. The LED goes out when the power is turned off or the power source is disrupted. When it is blinking green, it indicates that the system is in standby mode.

Rear Panel - Power Supply LED	Status	Condition
	Off	No DC power to all PSU
	Amber	No DC power to this PSU only
	Blink Green	DC present / Only Standby Outputs On
	Green	Power supply DC outputs ON and OK
	Blink Amber	Power Supply in Alert Condition
	Amber	Power supply failure

2.9 Ethernet Interfaces

Quantity:	Two
Connector:	RJ45
Data Rate:	10Base-T and 100BaseTX (10Mbit/s and 100Mbit/s) automatically detected and switched

2.10 Physical Specifications

Height:	3.5 inches (89 mm)	
Depth:	20 inches (508 mm)	
Width:	17.5 inches (445 mm)	
Front clearance	2 inches (76 mm)	
Side clearance	1 inch (25 mm)	
Rear clearance	3.6 inches (92 mm)	
Weight:	15.15 kg	DC version, 3 Signalling Cards, single power supply
	16.0 kg	DC version, 3 Signalling Cards, dual power supply
	15.25 kg	AC version, 3 Signalling Cards, single power supply
	16.1 kg	AC version, 3 Signalling Cards, dual power supply

2.11 Environmental

Operating temperature	5°C to 40°C (41°F to 104°F)
Storage temperature	-40°C to 70°C (-104°F to 158°F)
Humidity non-operating	95%, non-condensing at temperatures of 23 °C (73 °F) to 40 °C (104 °F)
Acoustic	Sound pressure: < 55 dBA at ambient temperatures < 28 °C measured at bystander positions in operating mode. Sound power: < 6.5 BA at ambient temperatures < 28 °C in operating mode.

2.12 Reliability

MTBF:	TBD hours MIL-HDBK 217F Notice 2 Ground Benign @ 25°C
-------	--

2.13 Regulatory Approvals

Safety:	EN 60950: 2000 UL 60950 3rd Edition IEC 60950 3rd Edition 1999 AS/NZS 3260
EMC ¹ :	ETSI EN 300 386: 2001 EN 55022: 1998 EN 55024: 1998 EN 61000-3-2: 1995 EN 61000-3-3: 1995 FCC Part 15, subpart B, class A AS/NZS 3548: 1995
Telecoms	TBR13

¹ See Appendix B for important information regarding the EMC performance of this equipment.

3. Hardware description

Paragraph 2.10 Physical Specifications lists the server's weight and dimensions.

The SIU520/SG430 is a rack-mounted server that is equipped with two Intel Pentium III processors and 512 Mbytes of SDRAM memory. The SIU520/SG430 can be fitted with up to three signalling cards providing up to 12 signalling links, 6 PCM ports and 6 V11 serial ports. The server supports high availability features such as hot-swap and redundant power supply modules. The standard server is supplied with a single AC or DC supply as determined at time of order.

3.1 Overview

Figure 3-1 presents a view of the SIU520/SG430 chassis.



OM12851

Figure 3-1. SIU520/SG430 Chassis

3.2 Front Panel

Figure 3-2 shows the front view of the system including the front panel. The front panel contains system control switches, alarm indicators and relays, and status indicators. Front panel controls and LEDs are summarized in Table 3-1.

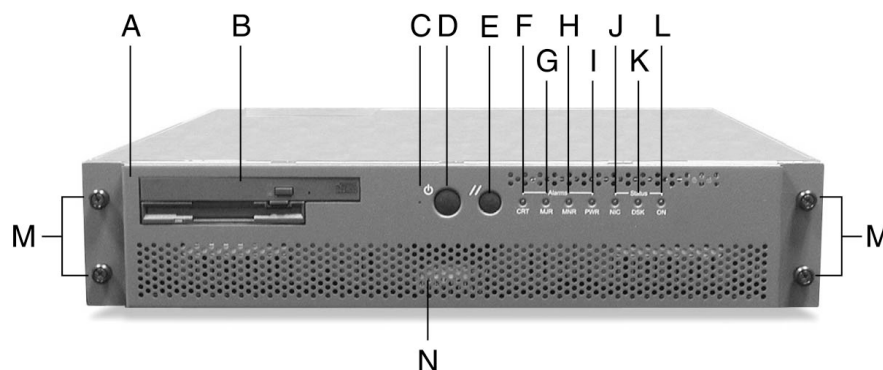

OM12816

A	Bezel	E	Reset Switch	I	Alarm: PWR	M	Bezel Removal Thumbscrews
B	Peripheral Bay	F	Alarm: CRT	J	Status: NIC	N	Hard Drive Tray
C	NMI Switch	G	Alarm: MJR	K	Status: DSK		
D	Power Switch	H	Alarm: MNR	L	Status: ON		

Figure 3-2. Front Panel

Table 3-1. Front Panel Features

Item	Feature	Description
C	NMI switch	Not used.
D	Power switch	Toggles the system power on/off.
E	Reset switch	Reboots and initializes the system.
F	Critical Alarm (amber)	When continuously lit, indicates the presence of a Critical System Fault. Additionally, the front panel critical alarm relay will engage. For a full definition of this alarm refer to the Configuration Manual.
G	Major Alarm (amber)	When continuously lit, indicates the presence of a Major System Fault. Additionally, the front panel major alarm relay will engage. For a full definition of this alarm refer to the Configuration Manual.
H	Minor Alarm (amber)	When continuously lit, indicates the presence of a Minor System Fault. Additionally, the front panel minor alarm relay will engage. For a full definition of this alarm refer to the Configuration Manual.
I	Power Alarm (amber)	When continuously lit, indicates the presence of a Power System Fault. Additionally, the front panel power alarm relay will engage.
J	NIC activity LED (green)	Indicates NIC activity.
K	HDD activity LED (green)	Indicates any system hard drive activity.
L	Main power LED (green)	When continuously lit, indicates the presence of DC power in the server. The LED goes out when the power is turned off or the power source is disrupted. When it is blinking green, it indicates that the system is in standby mode.

Figure 3-3 shows the front view of the system with the bezel removed.

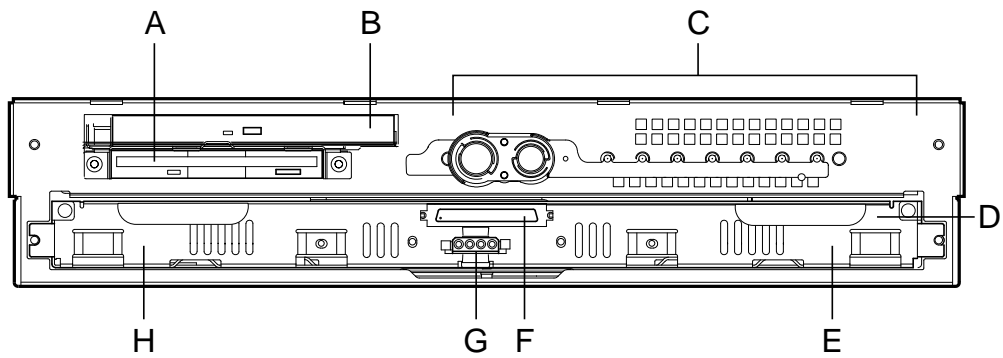

OM12817

- | | | | |
|---|-------------------------------|---|--|
| A | Floppy Drive | E | Left SCSI Drive Bay |
| B | CD-ROM Drive | F | Hard Drive Tray Ribbon Cable Connector |
| C | Front Panel Switches and LEDs | G | Hard Drive Tray Power Connector |
| D | Hard Drive Tray | H | Right SCSI Drive Bay |

Figure 3-3. Front View with Bezel Removed

3.3 Back Panel

Figure 3-4 shows the back panel view of the system.

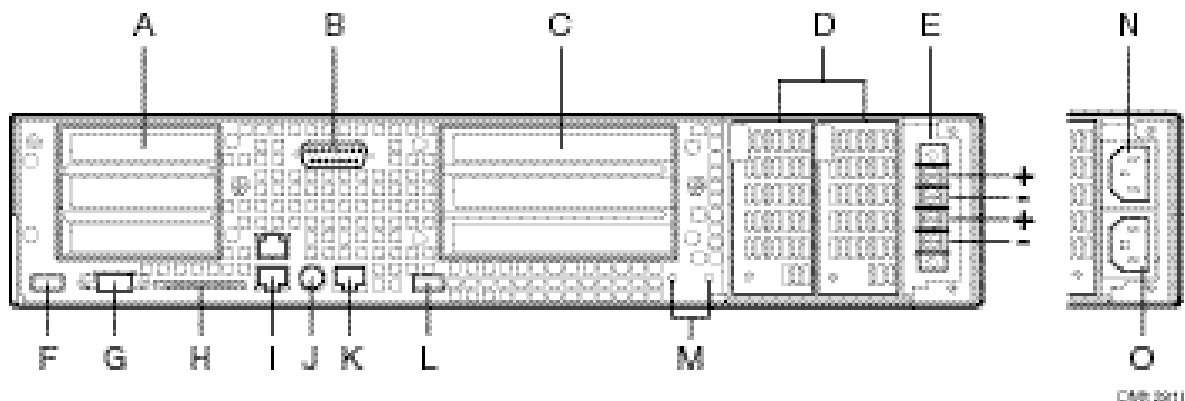

Figure 3-4. Back Panel DC Version, AC Version Shown at Right

Table 3-2. Back Panel Features

Item	Description
A	Not used.
B	DB-15 male connector for alarm relay contacts
C	Up to three Signalling Cards
D	Redundant, hot-plug power supplies (AC and DC power supplies require different power supply cages). As standard chassis is supplied with a single power supply fitted in the right hand position as viewed from rear.
E	Four-terminal DC input power connector for DC input power supply cage
F	USB port 1 (Not used)
G	Video connector (Not used)
H	External wide SCSI Ultra160 68-pin connector (Not used)
I	Dual NIC 10/100 E/N RJ45 connectors NIC 1 (lower) and NIC 2 (upper)
J	PS/2 [†] -compatible keyboard port (Not used)
K	Serial port (COM2), 8-pin RJ45 connector
L	USB port 0 (Not used)
M	Two grounding lugs for attachment of grounding wire to chassis. Use only when configured with DC input power supply
N and O	AC input power connectors for AC input power supply cage (shown in inset). AC connector N connects to the left power supply and AC connector O connects to the right power supply

4. Interfaces

This section gives connector pin out details for all used I/O interface connectors of the SIU520/SG430.

4.1 Alarms

The alarms port interface is a standard DB15-pin connector (see Figure 4-1). This connector allows remote notification of alarm conditions. Each alarm (Major, Minor, Critical and Power) is the output of a STDT relay contact. A common contact with normally open and normally closed connections is included. Power alarm has just a common and normally open contact outputs.



CAUTION

Do not apply more than 60 Volts (maximum) to any pin or combination of pins on the Alarms connector.

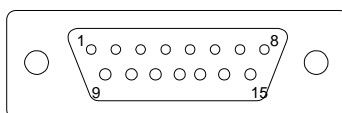

Figure 4-1. 15-pin Alarms Connector

Table 4-1. Alarms Connector Pinout

Pin	Description	Pin	Description
1	Not used	9	Minor alarm normally closed
2	Not used	10	Minor alarm common
3	Not used	11	Major alarm normally open
4	Not used	12	Major alarm normally closed
5	Critical alarm normally open	13	Major alarm common
6	Critical alarm normally closed	14	Power alarm normally open
7	Critical alarm common	15	Power alarm common
8	Minor alarm normally open		

4.2 DC Power Input

A DC power terminal block is provided at the rear of the DC-input power supply cage. It is recommended to use appropriately sized power wire and DC mains.

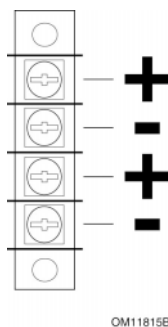

Figure 4-2. DC Power Input Connector

The terminal block will accept standard terminal lugs size Newark* stock # 81N1501 type CRS-T0-1406-HT that accept 14 AWG wire gauge. The width (W in Figure 4-3) of the lug can be no larger than 0.25 inches.



Figure 4-3. DC Power Terminal Lug

To connect the earth ground conductor to the chassis stud:

1. Place a #8-32 nut on the chassis stud and tighten to 10 in-lb.
2. Place the earth ground wire terminal lug on the chassis stud.
3. Place another #8-32 nut on the chassis stud so that the earth ground wire terminal is between the two nuts and tighten the second nut to 10 in-lb.

4.3 Serial Ports

One serial port is provided on the rear I/O to supply COM2 using an 8-pin RJ45 connector (see Table 4-2). The COM2 serial port can be used either as an emergency management port or as a normal serial port. As an emergency management port (EMP), COM2 is used as a communication path by the server management software that provides a level of emergency management through an external modem. . describes the serial port's connections.

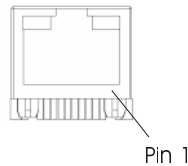

Figure 4-4. Serial Ports A and B

Table 4-2. Serial Port Connector pin-out

Pin	Signal	Description
1		
2	DTR	Data terminal ready
3	TXD	Transmit data
4	GND	
5		
6	RXD	Receive data
7	DSR	Date set ready
8		

A RJ45 to DB9 Serial cable is supplied with the server (Table C-1). This cable converts from the RJ45 connector pin out detailed in Table 4-2 to a conventional 9-way female D connector. The pin-out of these is defined in Table 4-3.

Table 4-3. 9-way DB9 Serial Cable pin-out

Pin	Signal	Description
1		
2	TXD	Transmit data
3	RXD	Receive data
4		
5	GND	
6	DTR	Data terminal ready
7	DSR	Date set ready
8		

4.4 PCM Interface Ports

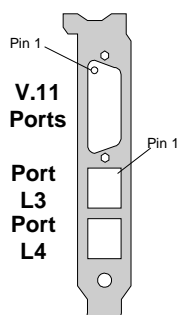

Figure 4-5. Signalling Card Connector Positions

Connections to the balanced E1/T1/J1 trunks are made via female RJ45 connectors. The connectors are labelled L3 and L4.

The connector pin-out and signal descriptions are shown in the following table. Note that pin 1 is towards the top of the board for each RJ45 connector.

The E1/T1/J1 ports on the Signalling cards are Safety Extra Low Voltage, SELV – the apparatus connects to the network via network termination units (NT1).

Table 4-4. Balanced line interface connector pin-out

Pin No	Direction	Function
1	Input	Receive
2	Input	Receive
3		No connection
4	Output	Transmit
5	Output	Transmit
6		No connection
7		No connection
8		No connection

4.5 SS7 Serial Interface Ports

The serial interface board provides two synchronous serial ports. Both ports are presented in the same female 26 way high density D-type connector and use V.11 (V.35 compatible) electrical interface characteristics.

The SS7 serial interface ports on the signalling cards are designated as SELV.

The serial port interface may be clocked either by an internally generated clock or by an externally applied clock. In both cases the same clock is used for both the transmit data and the receive data.

For internal clock operation use the transmit clock pins and make no connection to the receive clock pins on the D-type connector. For external clock operation connect the clock source to the receive clock pins on the D-type connector and make no connection to the transmit clock pins.

The connector pin-out and signal assignment is shown in Table 4-5.

Table 4-5. V.11 Serial interface connector pin-out

Pin No	Direction	Function
1		Chassis ground
2	Output	V11 Transmit inverted clock Port B
3	Output	V11 Transmit clock Port B
4	Output	V11 Transmit inverted data Port B
5	Output	V11 Transmit true data Port B
6	Input	V11 Receive inverted clock Port B
7	Input	V11 Receive clock Port B
8	Input	V11 Receive inverted data Port B
9	Input	V11 Receive true data Port B
10		Signal ground
11 .. 18		Do not connect
19	Output	V11 Transmit inverted clock Port A
20	Output	V11 Transmit clock Port A
21	Output	V11 Transmit inverted data Port A
22	Output	V11 Transmit true data Port A
23	Input	V11 Receive inverted clock Port A
24	Input	V11 Receive clock Port A
25	Input	V11 Receive inverted data Port A
26	Input	V11 Receive true data Port A

A dual V.11(V.35) to dual DB15 serial port break out cable is available (Table C-1). This is a Y cable which converts from the 26-way high density D connector detailed in Table 4-5 to two 15-way male D connectors. The pin-out of these is defined in Table 4-6.

Table 4-6. 15-way Male D-Connector Serial Port Breakout Cable

Pin No	Direction	Function
1		Chassis ground
2	Output	V11 Transmit true data Port
3		
4	Input	V11 Receive true data Port
5		
6	Input	V11 Receive true clock Port
7	Output	V11 Transmit true clock Port
8		Signal Ground
9	Output	V11 Transmit inverted data Port
10		
11	Input	V11 Receive inverted data Port
12		
13	Input	V11 Receive inverted clock Port
14	Output	V11 Transmit inverted clock Port
15		

Part II: Service Technician's Guide

5 Maintenance

This section describes procedures that **REQUIRE** internal server access. You must be a qualified service technician to perform procedures listed in the *Service Technician's Guide*.



WARNING

Only a QUALIFIED SERVICE TECHNICIAN is authorized to remove the server covers and to access any of the components inside the server. Before removing the covers, see “Safety: Before You Remove Server Covers” on page 31 and “Warnings and Cautions” on page 31.



WARNING

Do not attempt to modify or use an AC power cord that is not the exact type required. You must use a power cord that meets the following criteria:

- 1. Rating: For U.S./Canada cords must be UL Listed/CSA Certified type SJT, 18-3 AWG. For outside U.S./Canada cords must be flexible harmonized (<HAR>) or VDE certified cord with 3 x 0.75 mm conductors rated 250 VAC.**
- 2. Connector, wall outlet end: Cords must be terminated in grounding-type male plug designed for use in your region. It must have certification marks showing certification by an agency acceptable in your region and for U.S. must be rated 125% of overall current rating of the server.**
- 3. Connector, server end: The connector that plugs into the AC receptacle on the server must be an IEC 320, sheet C19, type female connector.**
- 4. Cord length and flexibility: Cords must be less than 4.5 meters (14.76 feet) long.**
- 5. Only use a screwdriver tip to push in the lock tabs on the rack slides. A pinch hazard exists if fingers are used for this purpose.**

Equipment Rack Precautions

WARNING

ANCHOR THE EQUIPMENT RACK: The equipment rack must be anchored to an unmovable support to prevent it from falling over when one or more servers are extended in front of it on slide assemblies. The equipment rack must be installed according to the manufacturer's instructions. You must also consider the weight of any other device installed in the rack.

MAIN AC POWER DISCONNECT: You are responsible for installing an AC power disconnect for the entire rack unit. This main disconnect must be readily accessible, and it must be labelled as controlling power to the entire unit, not just to the server(s).

GROUNDING THE RACK INSTALLATION: To avoid the potential for an electrical shock hazard, you must include a third wire safety grounding conductor with the rack installation. If server power cords are plugged into AC outlets that are part of the rack, then you must provide proper grounding for the rack itself. If server power cords are plugged into wall AC outlets, the safety grounding conductor in each power cord provides proper grounding only for the server. You must provide additional, proper grounding for the rack and other devices installed in it.

OVER CURRENT PROTECTION: The server is designed for an AC line voltage source with up to 20 amperes of over current protection. If the power system for the equipment rack is installed on a branch circuit with more than 20 amperes of protection, you must provide supplemental protection for the server. If more than one server is installed in the rack, the power source for each server must be from a separate branch circuit.

WARNING

ANTI-STATIC HANDLING PROCEDURES: The SIU520 and SG430 contain Electrostatic Sensitive Devices (ESDs) which may be permanently damaged if incorrectly handled. If modules are removed from the chassis they must be handled in accordance with appropriate anti-static handling procedures. Refer to: *EN100015-1 Basic Specification: Protection of Electrostatic Sensitive Devices: Part 1 General Requirements* for further details.

WARNING

AUSTRALIA AND NEW ZEALAND SPECIFIC: To comply with the relevant safety requirements in these countries, connection of this equipment **MUST** be via a Line Isolation Unit with a telecommunications compliance label.



WARNING

USA AND CANADA SPECIFIC: To comply with the relevant safety requirements in these countries, connection of this equipment to the public network **MUST** be via a network terminating device. (i.e. the unit must **NOT** be directly connected to the external public line).



CAUTION

Temperature: The operating temperature of the server, when installed in an equipment rack, must not go below 5 °C (41 °F) or rise above 40 °C (104 °F). Extreme fluctuations in temperature can cause a variety of problems in your server.

Ventilation: The equipment rack must provide sufficient airflow to the front of the server to maintain proper cooling. The rack must also include ventilation sufficient to exhaust a maximum of 1023 BTU's per hour for the server. The rack selected and the ventilation provided must be suitable to the environment in which the server will be used.

5. Maintenance

5.1 Tools and Supplies Needed

Procedures in this section require the following tools and supplies:

- Jumper-removal tool or needle-nosed pliers
- Small flat-bladed screwdriver
- Phillips† (cross-head) screwdriver (#2)
- Pen or pencil
- Anti-static wrist strap and conductive foam pad (recommended)

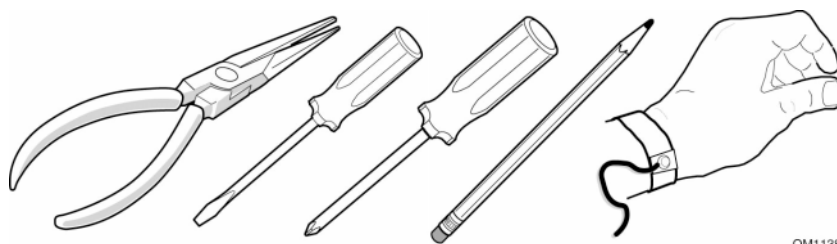

Figure 5-1. Tools and Supplies Needed

Record the model and serial number of the system, all installed options, and any other pertinent information specific to the system.

5.2 Cautions

These warnings and cautions apply throughout this chapter. Only a technically qualified person should configure the server hardware.



CAUTIONS

System power on/off: The power button DOES NOT switch off system power. To remove power from the system, you must unplug/disconnect the power connections. Make sure power connections are unplugged/disconnected before you open the chassis, add, or remove any components.

Hazardous conditions, devices and cables: Hazardous electrical conditions may be present on power, telephone, and communication cables. Turn off the server and disconnect the power cord, telecommunications systems, networks, and modems attached to the server before opening it. Otherwise, personal injury or equipment damage can result.

Electrostatic discharge (ESD) and ESD protection: ESD can damage disk drives, boards, and other parts. We recommend that you perform all procedures in this chapter only at an ESD workstation. If one is not available, provide some ESD protection by wearing an antistatic wrist strap attached to chassis ground (any unpainted metal surface) on your server when handling parts.

ESD and handling boards: Always handle boards carefully. They can be extremely sensitive to ESD. Hold boards only by their edges. After removing a board from its protective wrapper or from the server, place the board component side up on a grounded, static free surface. Use a conductive foam pad if available but not the board wrapper. Do not slide board over any surface.

5.3 Replacing Power Supply Modules

To replace an AC or DC power supply module, follow this procedure:

1. Depress the locking tab (A in Figure 5-2).
2. Rotate the handle downward (B in Figure 5-2).
3. Using the handle, pull the power supply outward (C in Figure 5-2).
4. Reverse these steps for installation.

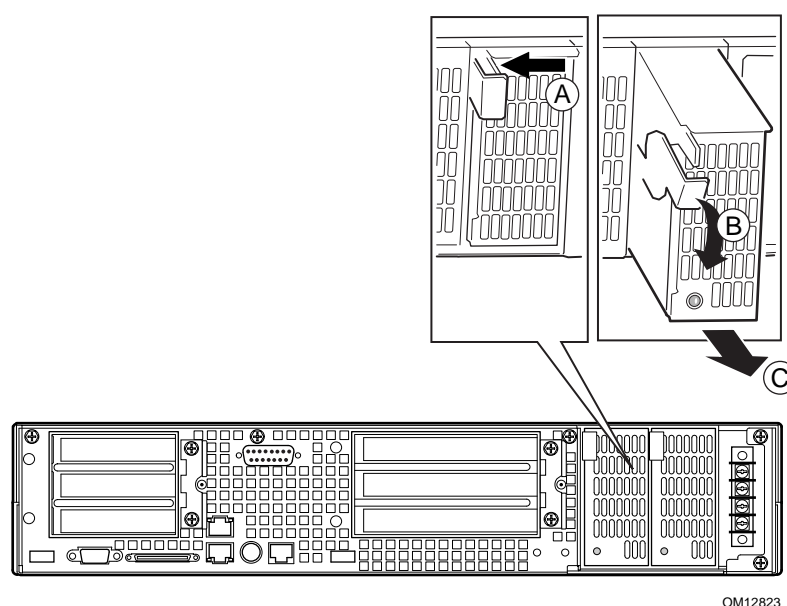

OM12823

Figure 5-2. Unlocking and Removing the Power Supply Modules

5.4 Working Inside the System

This section presents the following procedures that describe removal and installation of most components inside the system.

5.4.1 Safety: Before You Remove Server Covers

Before removing covers at any time to work inside the system, observe these safety guidelines.

1. Turn off all peripheral devices connected to the system.
2. Power down the system by pressing and holding the Power button on the front of the chassis for several seconds. After the server shuts down, unplug/disconnect the power cord to remove standby power from the server.
3. Label and disconnect all peripheral cables and all telecommunication lines connected to I/O connectors or ports on the back of the system.

Provide electrostatic discharge (ESD) protection by wearing an anti-static wrist strap attached to chassis ground of the system-any unpainted metal surface-when handling components.

5.4.2 Warnings and Cautions

These warnings and cautions apply whenever you remove covers of the system. Only a technically qualified person should integrate, configure, or service the system.



WARNINGS

Power Button: Shutting down the server with the Power button on the front of the chassis DOES NOT remove all power from the system. To remove all power from system, you must also unplug/disconnect the power cord from the system.

Unplugging/disconnecting the power cord from the system removes the +12 Volt standby power that is present when the server is powered down.

Hazardous conditions, power supply: Hazardous voltage, current, and energy levels are present inside the power supply. There are no user-serviceable parts inside the power supply; technically qualified personnel should do servicing.

Hazardous conditions, devices, and cables: Hazardous electrical conditions may be present on power, telephone, and communication cables. Turn off the system and unplug/disconnect the power cord, telecommunications systems, networks, and modems attached to the system before opening it. Otherwise, personal injury or equipment damage can result.

Hazardous conditions, processors and power supplies: Thermal conditions may be present in the Processor/Memory Complex. Allow all fans to continue to run until they shut down on their own after power has been turned off. After the fans stop, you can unplug/disconnect the power cord.



CAUTIONS

Electrostatic discharge (ESD) and ESD protection: ESD can damage disk drives, boards, and other parts. We recommend that you do all procedures in this section only at an ESD-protected workstation. If one is not available, provide some ESD protection by wearing an anti-static wrist strap attached to chassis ground—any unpainted metal surface—on your system when handling parts.

ESD and handling boards: Always handle boards carefully. They can be extremely sensitive to ESD. Hold boards only by their edges. After removing a board from its protective wrapper or from the system, place it on a grounded surface free of static electricity. Do not slide boards over any surface.

Cooling and airflow: For proper cooling and airflow, always install the chassis covers before turning on the system. Operating the system without the covers in place can damage system parts.

5.4.3 Removing and Installing the Top Cover

CAUTION

For proper cooling and airflow, do not operate the server with the cover removed. Always reinstall the cover before turning the server on.

The server comes with a removable Top Cover. Removal of this cover is necessary when installing or removing many components. You do not have to remove the Top Cover when removing or installing power supplies or hard drives.

WARNING

If rack mounted, make sure that the rack is anchored securely so it will not tilt forward when the server chassis is extended. A crush hazard exists should the rack tilt forward that could cause serious injury.

Only use a screwdriver tip to push in the lock tabs on the rack slides. A pinch hazard exists if fingers are used for this purpose.

To remove the top cover, follow this procedure:

1. Remove the four screws along the rear panel (A in Figure 5-3) that secure the top cover to the chassis.
2. Slide the top cover rearward (B in Figure 5-3) to release it from the chassis.
3. Lift the top cover up to remove.

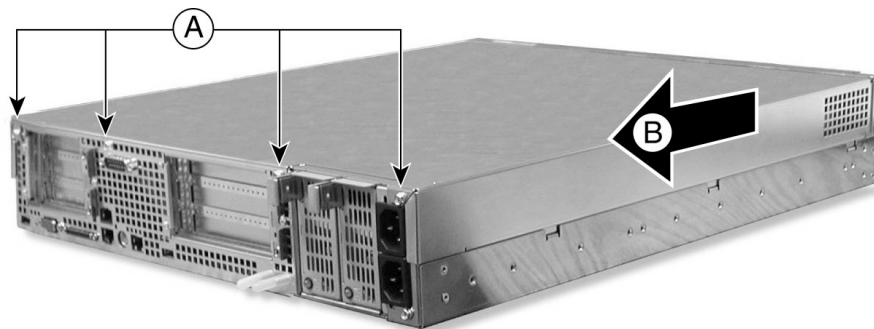

OM12825

Figure 5-3. Removing the Top Cover

5.4.4 Internal Chassis Layout

The server board contains a riser card permitting up to three Signalling cards to be fitted (C).

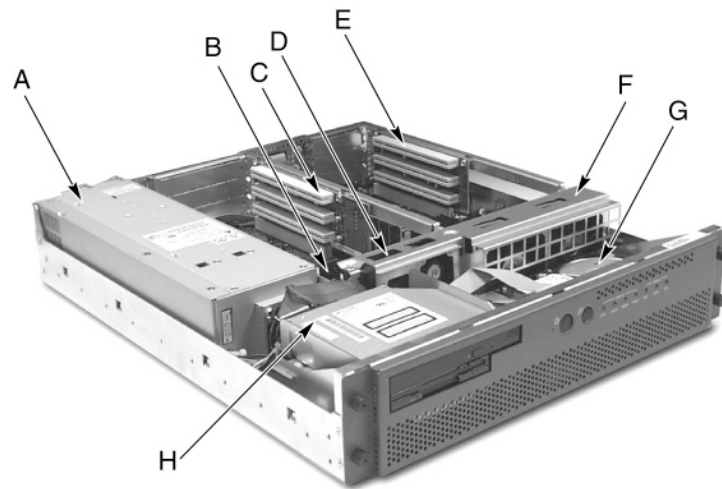

OM12819

- | | | | |
|---|-----------------------|---|---------------------------|
| A | Power Supply Cage | E | 3.3 PCI Add-in Card Riser |
| B | Server Board | F | Fan Bracket |
| C | Signalling Card Riser | G | SCSI Hard Disk Drive Tray |
| D | Fan Module | H | Peripheral Bay |

Figure 5-4. Internal Chassis Layout

5.4.5 Signalling Card Configuration

The chassis supports up to three Signalling Cards mounted on the Signalling Card Riser board (C in Figure 5-4).

Before installing the Signalling cards ensure that the bus termination jumpers are correctly set on the cards. Signalling cards at either end of the ribbon cable must terminate the clock lines, this is achieved by fitting links at all positions on the link field labelled CLK TERM (J3) Figure 5-5.

It is important when sub-populating the number of signalling cards in the unit that connection to the CT Bus are made in a predetermined manner. For this reason when fitting two cards these should be fitted in positions 1 and 3 and connected together using the end connectors of the ribbon cable. Both cards terminate the clock lines and must be configured as detailed above.

Set the ADDR switch (Figure 5-5) on the Signalling card as in the following table.

Table 5-1. Signalling Card Address Switch Settings

Board Position	ADDR Switch Setting
3	2
2	1
1	0

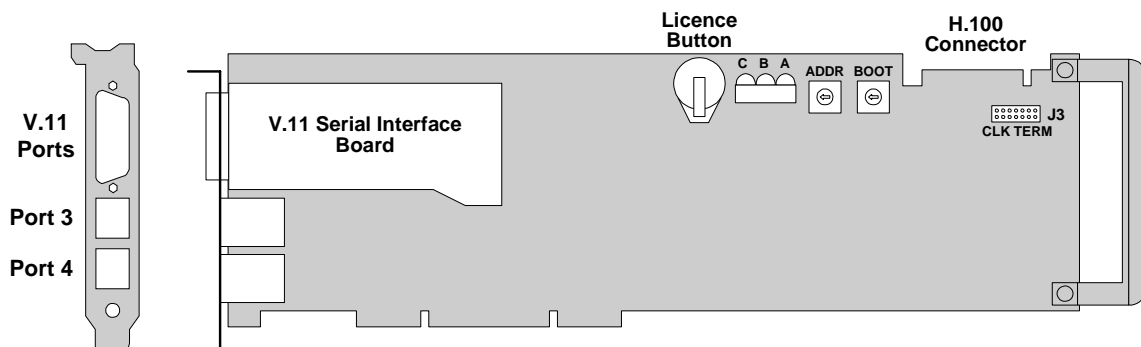

Figure 5-5. Signalling Card with 2 PCM ports and V.11 serial interface board.

5.4.6 Signalling Card Installation

Before installation in the server the Signalling cards must be correctly configured as detailed in paragraph 5.4.5.

To replace or add additional Signalling cards:

1. Remove the two screws (A in Figure 5-6) securing the PCI retainer bracket at the rear of the chassis.

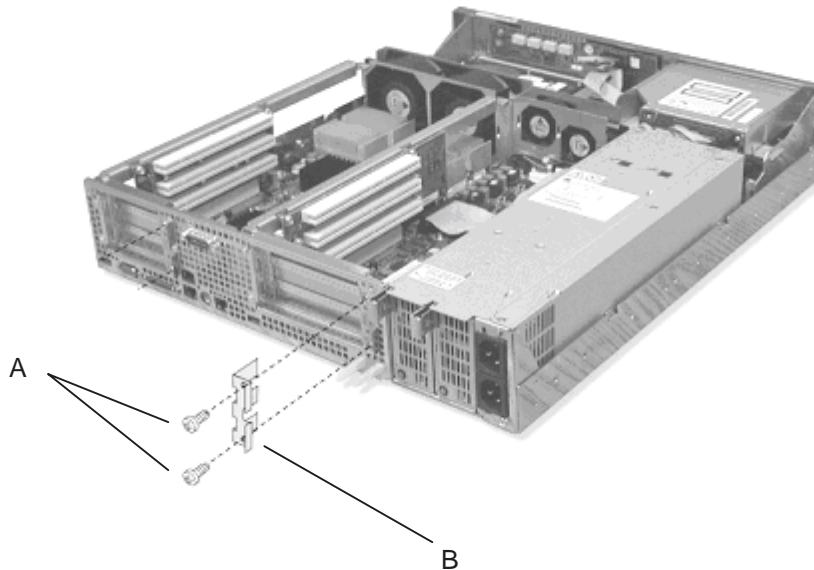
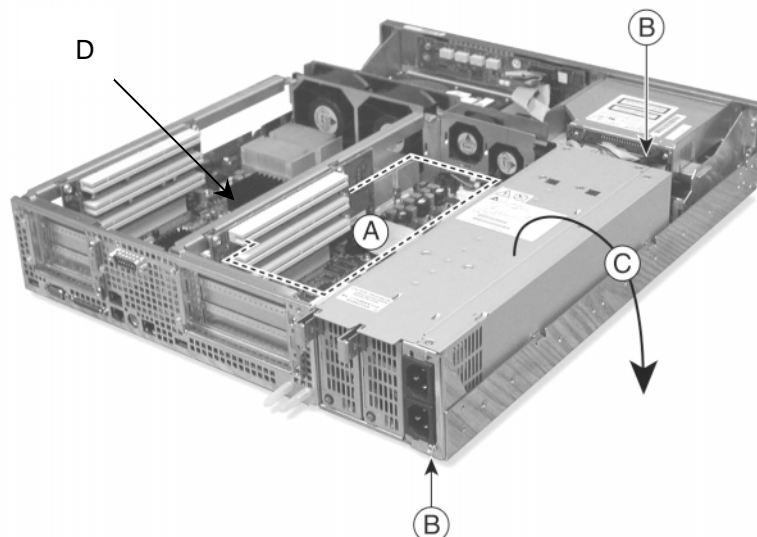

Figure 5-6. PCI Retainer Bracket Location

2. Rotate the PCI retainer bracket (B in Figure 5-6) to the left and slide out to remove.
3. If adding additional card(s) remove the appropriate PCI blanking panel(s).
4. Remove the two screws (B in Figure 5-7) holding the power supply cage in place.
5. Remove the screw below the fan at the front of the power cage assembly.
6. Slide the power supply cage assembly towards the front of the chassis, ensuring that the power inlets are clear of the chassis metalwork
7. Lift the back of the power supply and rotate it (C in Figure 5-7) so that it is placed outside of the unit. (This can be done without disconnecting the cable harness but care must be exercised to ensure that the cables are not stressed.)



OM12829

Figure 5-7. Signalling Card Installation

8. Remove the centre bar (D in Figure 5-7), by removing the screws, lifting the rear and sliding the front out. One screw connects the centre bar to the fan cover and two connect to the 5V PCI riser card.
9. The centre bar can then be lifted out and the riser card can be removed.
10. Remove two screws, one at either end, retaining the fan bracket (F in Figure 5-4); the fan bracket will then pull away.
11. Connect the first connector on the ribbon cable to the H100 connector on the Signalling card.
12. Align the front end of the Signalling card with the bottom PCI opening at the rear of the chassis, taking care not to damage the PCI slot gasket.
13. Slide the end of the card down whilst applying pressure to the PCI card retainer clip, until the card has reached the lowest position on the retainer.
14. Follow the same procedure for inserting the two remaining Signalling cards to the middle and top PCI slots, ensuring that the ribbon cable is connected as each card is positioned.
15. Replace the riser card in the chassis.
16. Starting with the top Signalling card, align the card with the PCI slot on the riser and apply pressure to attach the card. Repeat this for the middle and bottom Signalling cards.
17. Replace the fan bracket, F in Figure 5-4, this will click in to place. Secure using two screws, one at either end, of the fan bracket.
18. Replace the centre bar; fit the screw connecting to the fan bracket and the two screws to the riser card.
19. Insert the PCI retaining bracket at the rear of the chassis, inserting at 45 degrees to the chassis to ensure that the Signalling card end brackets are retained.
20. Apply pressure to straighten the PCI retaining bracket and replace the two screws. Ensure correct alignment of the Signalling cards whilst tightening the bracket.
21. Return the power cage to the chassis and replace the two screws.

5.4.7 Replacing the Back Up Battery

The lithium battery on the server board powers the real time clock (RTC) for up to 10 years in the absence of power. When the battery starts to weaken, it loses voltage, and the server settings stored in CMOS RAM in the RTC (for example, the date and time) may be wrong. Contact your customer service representative or dealer for a list of approved devices.



WARNING

Danger of explosion if battery is incorrectly replaced. Replace only with the same or equivalent type recommended by the equipment manufacturer. Discard used batteries according to manufacturer's instructions.



ADVARSEL!

Lithiumbatteri - Eksplosjonsfare ved fejløgt håndtering. Udskiftning må kun ske med batteri af samme fabrikat og type. Levér det brugte batteri tilbage til leverandøren.



ADVARSEL

Lithiumbatteri - Eksplosjonsfare. Ved utskifting benyttes kun batteri som anbefalt av apparatfabrikanten. Brukt batteri returneres apparatleverandøren.



VARNING

Explosionsfara vid felaktigt batteribyte. Använd samma batterityp eller en ekvivalent typ som rekommenderas av apparattillverkaren. Kassera använt batteri enligt fabrikantens instruktion.



VAROITUS

Paristo voi räjähtää, jos se on virheellisesti asennettu. Vaihda paristo ainoastaan laitevalmistajan suositteluun tyyppiin. Hävitä käytetty paristo valmistajan ohjeiden mukaisesti.

To replace the backup battery, follow this procedure:

1. Observe the safety and ESD precautions at the beginning of this chapter.
2. Remove the top cover and locate the backup battery on the server board (see Figure 5-8).
3. Insert the tip of a small flat bladed screwdriver, or equivalent, under the tab in the plastic retainer. Gently push down on the screwdriver to lift the battery.
4. Remove the battery from its socket.
5. Dispose of the battery according to local ordinance.
6. Remove the new lithium battery from its package, and, being careful to observe the correct polarity, insert it in the battery socket.
7. Reinstall the plastic retainer on the lithium battery socket.
8. Replace the top cover.
9. Restore the configuration settings to the RTC as detailed in the Configuration Manual.

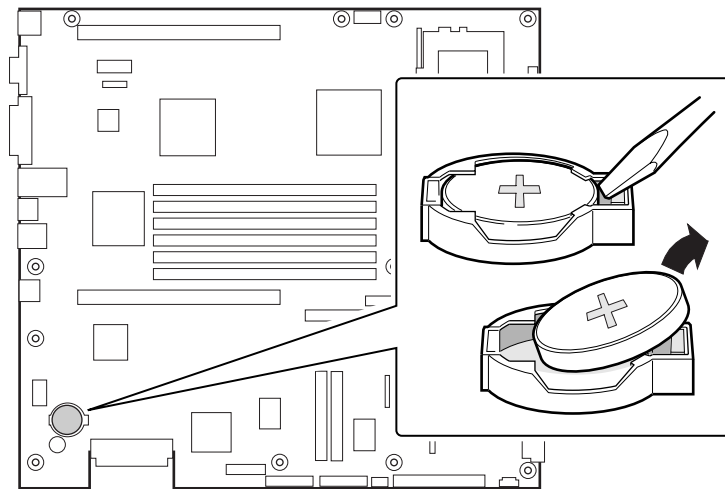

OM12830

Figure 5-8. Replacing the Backup Battery

A. Warnings

WARNING: English

AVERTISSEMENTS : Français

WARNUNG: Deutsch

AVVERTENZA: Italiano

ADVERTENCIA: Español

A.1 WARNING: English

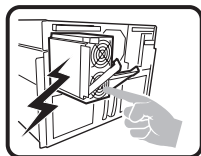

The power supply in this product contains no user-serviceable parts. There may be more than one supply in this product. Refer servicing only to qualified personnel.

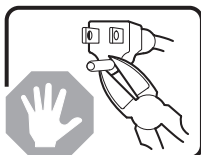

Do not attempt to modify or use the supplied AC power cord if it is not the exact type required. A product might be equipped with more than one AC power cord.

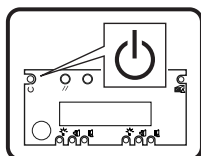

The Power button on the system does not turn off all system power. To remove all power from the system, you must unplug/disconnect the power cord from the system.



To avoid injury from electrical and mechanical hazards, chassis covers should only be removed by qualified service personnel.

SAFETY STEPS: Whenever you remove the chassis covers to access the inside of the system, follow these steps:

1. Turn off all peripheral devices connected to the system.
 2. Turn off the system by pressing the Power button.
 3. Unplug/disconnect the power cord from the system.
 4. Label and disconnect all telecommunication cables and all other cables connected to I/O connectors or ports on the back of the system.
 5. Provide some electrostatic discharge (ESD) protection by wearing an anti-static wrist strap attached to chassis ground of the system—any unpainted metal surface—when handling components.
 6. Do not operate the system with the chassis covers removed.
-

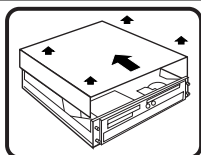

After you have completed the five SAFETY steps above, you can remove the system covers. To do this:

1. Remove and save all screws from the covers.
 2. Remove the covers.
-

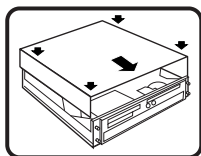

For proper cooling and airflow, always reinstall the chassis covers before turning on the system. Operating the system without the covers in place can damage system parts. To install the covers:

1. Check first to make sure you have not left loose tools or parts inside the system.
 2. Check that cables, add-in boards, and other components are properly installed.
 3. Attach the covers to the chassis with the screws removed earlier, and tighten them firmly.
 4. Connect all external cables and the power cord to the system.
-

continued

Warning: English (continued)

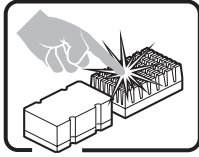

A microprocessor and heat sink might be hot if the system has been running. Also, there might be sharp pins and edges on some board and chassis parts. Contact should be made with care. Consider wearing protective gloves.

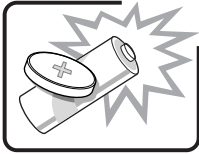

Danger of explosion if the battery is incorrectly replaced. Replace only with the same or equivalent type recommended by the equipment manufacturer. Discard used batteries according to manufacturer's instructions.

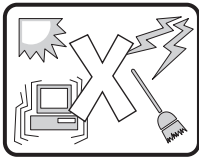

The system is designed to operate in a typical office environment. Choose a site that is:

- Clean and free of airborne particles (other than normal room dust).
 - Well-ventilated and away from sources of heat including direct sunlight.
 - Away from sources of vibration or physical shock.
 - Isolated from strong electromagnetic fields produced by electrical devices.
 - Protected when in regions that are susceptible to electrical storms. We recommend you plug your system into a surge suppresser and disconnect telecommunication lines to your modem during an electrical storm.
 - Provided with a properly grounded wall outlet.
 - Provided with sufficient space to access the power supply cords, because they serve as the product's mains power disconnect.
-

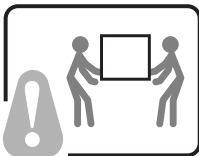

Servers can be too heavy for a single person to lift or move safely. Depending on the server, use two people or a mechanical assist to lift or move the server.

A.2 AVERTISSEMENTS : Français

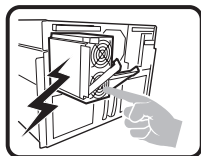

Le bloc d'alimentation de ce produit ne contient aucune pièce pouvant être réparée par l'utilisateur. Ce produit peut contenir plusieurs blocs d'alimentation. Veuillez contacter un technicien qualifié en cas de problème.

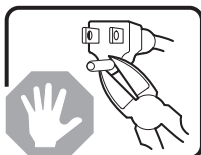

Ne pas essayer d'utiliser ni de modifier le câble d'alimentation CA fourni, s'il ne correspond pas exactement au type requis. Un produit peut être équipé de plus d'un câble d'alimentation CA.

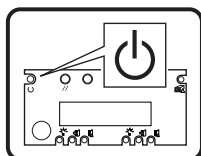

Le bouton d'alimentation du système n'éteint pas toutes les alimentations CA du système. Pour mettre complètement le système hors tension, vous devez débrancher chaque cordon d'alimentation CA de sa prise.



Pour éviter toute lésion à la suite de risques électriques et mécaniques, les panneaux du châssis ne doivent être démontés que par un personnel qualifié.

CONSIGNES DE SÉCURITÉ : Lorsque vous retirez les panneaux du châssis pour accéder à l'intérieur du système, suivez les étapes ci-dessous :

1. Mettez hors tension tous les périphériques connectés au système.
2. Mettez hors tension le système en appuyant sur le bouton d'alimentation.
3. Débranchez tous les cordons d'alimentation CA du système ou des prises murales.
4. Identifiez et déconnectez tous les câbles de télécommunications et tous les autres câbles reliés aux connecteurs E/S ou aux ports derrière le système.
5. Pour prévenir les décharges électrostatiques lorsque vous touchez aux composants, portez une bande antistatique pour poignet et reliez-la à la masse du système (toute surface métallique non peinte du boîtier).
6. Ne faites pas fonctionner le système si les panneaux du châssis sont enlevés.

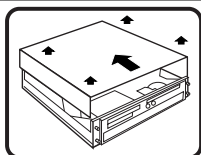

Après avoir suivi les six consignes de SECURITE ci-dessus, vous pouvez retirer les panneaux du système. Pour effectuer cette opération :

1. Retirez et conservez toutes les vis des panneaux.
2. Retirez les panneaux.

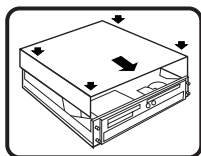

Afin de permettre le refroidissement et l'aération du système, réinstallez toujours les panneaux du châssis avant de mettre le système sous tension. Le fonctionnement du système en l'absence des panneaux risque d'endommager ses pièces. Pour installer les panneaux, procédez comme suit :

1. Assurez-vous ne pas avoir oublié d'outils ou de pièces démontées dans le système.
2. Assurez-vous que les câbles, les cartes d'extension et les autres composants sont bien installés.
3. Revissez solidement les panneaux du châssis avec les vis retirées plus tôt.
4. Rebranchez tous les cordons d'alimentation CA et câbles externes au système.

suite

Avertissements : Français (suite)

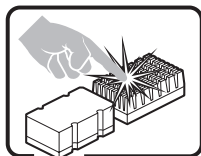

Le microprocesseur et le dissipateur de chaleur peuvent être chauds si le système a été sous tension. Faites également attention aux broches aiguës des cartes et aux bords tranchants du capot. Les contacts doivent être établis avec soin. L'usage de gants de protection est conseillé.

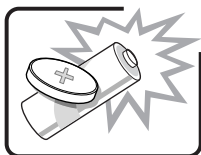

Danger d'explosion si la batterie n'est pas remontée correctement. Remplacer uniquement par une pile du même type ou de type équivalent recommandé par le fabricant. Débarrassez-vous des piles usagées conformément aux instructions du fabricant.

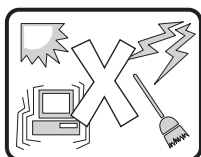

Le système a été conçu pour fonctionner dans un cadre de travail normal. L'emplacement choisi doit être :

1. Propre et dépourvu de poussières en suspension (sauf la poussière normale).
2. Bien aéré et loin des sources de chaleur, y compris du soleil direct.
3. À l'abri des chocs et des sources de vibration.
4. Isolé des forts champs électromagnétiques générés par des appareils électriques.
5. Protégé s'il se trouve dans des régions sujettes aux orages magnétiques. Nous vous recommandons de connecter votre système à un suppresseur de surtension et de déconnecter les lignes de télécommunications de votre modem pendant un orage magnétique.
6. Muni d'une prise murale correctement mise à la terre.
7. Suffisamment spacieux pour vous permettre d'accéder aux câbles d'alimentation (ceux-ci étant le seul moyen de mettre le système hors tension).

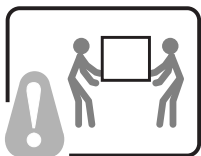

Il se peut que les serveurs soient trop lourds pour qu'une seule personne puisse les soulever et les déplacer en toute sécurité. En fonction du serveur, utilisez deux personnes ou utilisez un équipement mécanique auxiliaire pour soulever ou déplacer le serveur.

A.3 WARNUNG: Deutsch

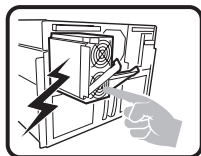

Das Netzteil dieses Computers enthält keine wartungsbedürftigen Teile. Dieses Produkt kann über mehrere Netzteile verfügen. Überlassen Sie Wartungsarbeiten nur qualifizierten Fachleuten.

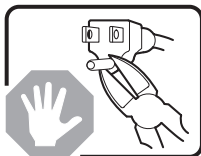

Versuchen Sie nicht, das mitgelieferte Netzkabel zu verändern oder einzusetzen, wenn es nicht exakt dem benötigten Kabeltyp entspricht. Das Produkt kann über mehrere Netzkabel verfügen.

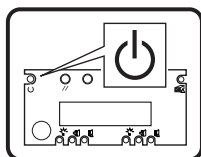

Durch Ausschalten des Netzschalters wird die Wechselstromversorgung des Systems nicht unterbrochen. Um das System vom Netz zu trennen, müssen Sie das Netzkabel aus der Steckdose oder vom Netzteil abziehen.

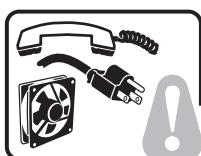

Vermeiden Sie Verletzungen aufgrund elektrischer oder mechanischer Gefahren; lassen Sie daher den Gehäusedeckel nur von technisch qualifiziertem Personal abnehmen.

SICHERHEITSHINWEISE: Beachten Sie beim Abnehmen der Gehäuseabdeckung und Arbeiten im Inneren des Systems folgende Schritte:

1. Schalten Sie alle am System angeschlossenen Peripheriegeräte ab.
2. Drücken Sie den Netzschalter, um das System abzuschalten.
3. Ziehen Sie alle Wechselstromkabel vom System und den Steckdosen ab.
4. Kennzeichnen Sie alle Telekommunikationsleitungen und sonstigen Kabel an den E/A-Steckern bzw. Anschlüssen an der Rückseite des Systems, und trennen Sie diese vom Netz.
5. Um sich gegen elektrostatische Entladung zu schützen, sollten Sie eine Antistatik-Manschette tragen, die Sie beim Arbeiten mit Komponenten zur Erdung an einem beliebigen unlackierten Metallteil befestigen.
6. Nehmen Sie das System nicht ohne Abdeckung in Betrieb.

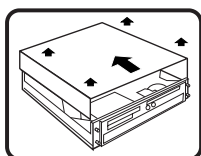

Nachdem Sie die fünf Sicherheitshinweise oben beachtet haben, können Sie die Gehäuseabdeckung abnehmen. Gehen Sie wie folgt vor:

1. Entfernen Sie sämtliche Schrauben der Gehäuseabdeckung, und bewahren Sie diese auf.
2. Nehmen Sie die Gehäuseabdeckung ab.

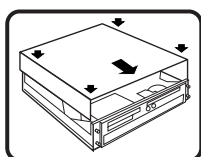

Um eine ordnungsgemäße Kühlung und Belüftung zu gewährleisten, sollten Sie stets die Gehäuseabdeckung anbringen, bevor Sie das System in Betrieb nehmen. Wenn das System ohne obere und vordere Abdeckung betrieben wird, kann es zu einer Beschädigung der Systemkomponenten kommen. So entfernen Sie die Gehäuseabdeckung:

1. Prüfen Sie, daß weder Werkzeuge noch Kleinteile im Innern des Systems vergessen wurden.
2. Prüfen Sie, ob die Kabel und anderen Komponenten richtig installiert sind.
3. Schrauben Sie die Abdeckung mit den zuvor gelösten Schrauben gut am Gehäuse fest.
4. Schließen Sie alle externen Kabel und das Netzkabel an das System an.

Fortsetzung

Warnung: Deutsch (Fortsetzung)

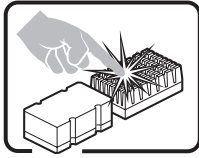

Mikroprozessor und Kühlkörper können heiß sein, wenn das System längere Zeit eingeschaltet war. Einige Platinen- und Gehäuseteile können scharfe Spitzen und Kanten aufweisen. Gehen Sie auf jeden Fall mit Vorsicht heran. Das Tragen von Schutzhandschuhen wird empfohlen.

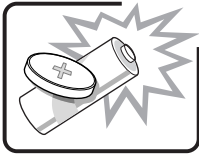

Wird die Batterie unsachgemäß ausgewechselt, besteht Explosionsgefahr. Ersetzen Sie die Batterie nur durch denselben oder einen gleichwertigen Batterietyp, der vom Gerätehersteller empfohlen wird. Entsorgen Sie verbrauchte Batterien gemäß den Herstellerempfehlungen.

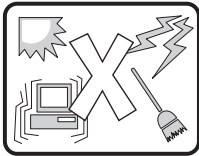

Das System ist für den Betrieb innerhalb normaler Büroumgebungen geeignet. Der Standort sollte folgende Anforderungen erfüllen:

- Saubere, möglichst staubfreie Umgebung.
 - Gut belüftet und weit entfernt von Wärmequellen wie direkte Sonneneinstrahlung.
 - Vibrations- und erschütterungsfreie Umgebung.
 - Abgeschirmt von starken elektromagnetischen Feldern, die durch elektrische Geräte erzeugt werden.
 - Entsprechender Schutz bei Betrieb in gewittergefährdeten Gebieten. Es empfiehlt sich, den Computer über einen Überspannungsschutz anzuschließen und die Verbindung zwischen dem Modem und dem Telefonanschluß im Falle eines Gewitters zu trennen.
 - Ausgestattet mit einer ordnungsgemäß geerdeten Wandsteckdose.
 - Sorgen Sie für ausreichend Platz, damit das Servernetzwerkabel problemlos erreicht werden kann, da das Gerät nur über dieses Kabel vom Netz getrennt wird.
-

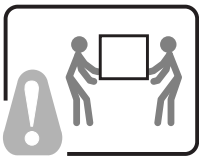

Um einen Server sicher anzuheben und zu bewegen ist eine Person nicht ausreichend. Bewegen Sie den Server, je nach Größe, entweder zu zweit oder mittels einer mechanischen Hilfe.

A.4 AVVERTENZA: Italiano

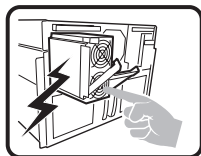

L'alimentatore contenuto nel computer non contiene parti riparabili dall'utente. Questo prodotto può essere fornito con più alimentatori. Per l'assistenza fare riferimento solo a personale qualificato.

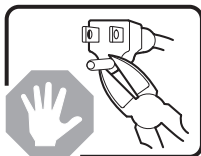

Non tentare di modificare o utilizzare cavi di alimentazione in c.a. che non siano del tipo prescritto. Un prodotto potrebbe contenere più di un cavo di alimentazione in c.a.

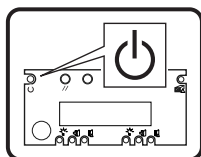

L'interruttore di accensione del sistema non scollega tutta l'alimentazione in c.a. del sistema. Per scollegare tutta l'alimentazione in c.a., è necessario disinserire ogni cavo di alimentazione in c.a. dalla presa a muro o dall'alimentatore.



Per evitare incidenti elettrici e meccanici, i coperchi del telaio devono essere rimossi da personale qualificato.

MISURE DI SICUREZZA: Nel caso sia necessario rimuovere i coperchi del telaio per accedere alle parti interne del sistema, procedere nel seguente modo:

1. Spegnerne tutte le periferiche collegate al sistema.
2. Spegnerne il sistema premendo il pulsante di accensione.
3. Scollegare tutti i cavi di alimentazione in c.a. dal sistema o dalle prese a muro.
4. Apporre un'etichetta e scollegare tutti i cavi di telecomunicazione e i cavi collegati ai connettori di I/O o alle porte sulla parte posteriore del sistema.
5. Assicurare un minimo di protezione da scariche elettrostatiche (ESD) indossando un bracciale antistatico collegato a un componente metallico non verniciato del telaio quando si maneggiano i componenti.
6. Non attivare il sistema nel caso in cui i coperchi del telaio siano stati rimossi.

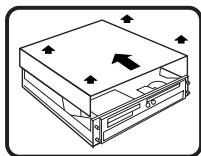

Dopo aver effettuato le operazioni di SICUREZZA descritte in precedenza, è possibile rimuovere i coperchi del sistema. Procedere nel modo seguente:

1. Rimuovere e conservare tutte le viti dei coperchi.
2. Rimuovere i coperchi.

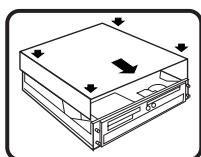

Per evitare che il sistema si surriscaldi e per garantire una ventilazione adeguata, reinstallare sempre i coperchi prima di attivare il sistema. Se si attiva il sistema senza aver riposizionato i coperchi correttamente, alcune parti del sistema potrebbero risultare danneggiate. Per installare i coperchi:

1. Verificare innanzitutto di non aver lasciato utensili o altre parti all'interno del sistema.
2. Verificare che i cavi, le schede aggiuntive e gli altri componenti siano stati installati correttamente.
3. Fissare saldamente i coperchi al telaio utilizzando le viti precedentemente rimosse.
4. Collegare tutti i cavi esterni e il cavo o i cavi di alimentazione in c.a. al sistema.

continua

Avvertenza: Italiano (continua)

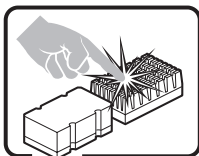

Se il sistema è stato in funzione, il microprocessore e il dissipatore di calore potrebbero essere caldi. Inoltre su alcune parti della scheda e del telaio potrebbero esserci piedini appuntiti e bordi taglienti. Prestare quindi molta attenzione nel toccarli. Indossare guanti protettivi.

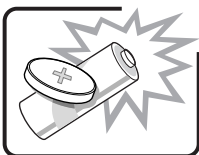

Se sostituita in modo errato, la batteria potrebbe esplodere. Sostituire le batterie scariche solo con batterie originali o del tipo consigliato dal produttore dell'apparecchiatura. Per lo smaltimento delle batterie usate attenersi alle istruzioni del produttore.

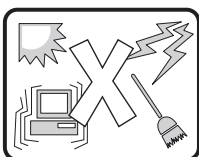

Il sistema è concepito per l'utilizzo in ambienti adibiti a ufficio. Scegliere una postazione con le caratteristiche riportate di seguito.

- Pulita, priva di particelle diverse dalla polvere normalmente presente nell'ambiente di lavoro.
 - Aerata e lontana da fonti di calore, compresa la luce solare diretta.
 - Lontana da fonti di vibrazione o urti.
 - Isolata da forti campi elettromagnetici prodotti da apparecchi elettrici.
 - Protetta nelle regioni soggette a temporali. Durante un temporale, si consiglia di collegare il sistema a un limitatore di corrente e di scollegare le linee di telecomunicazione dal modem.
 - La posizione prescelta deve essere dotata di una presa a muro con adeguata messa a terra.
 - Deve inoltre esserci sufficiente spazio per accedere ai cavi di alimentazione nel caso sia necessario scollegare l'alimentazione principale.
-

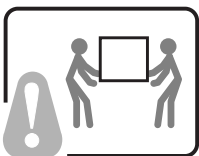

I server possono risultare troppo pesanti per essere sollevati o spostati da una sola persona. Alcuni server devono dunque essere sollevati o spostati da due persone o da un assistente tecnico.

A.5 ADVERTENCIA: Español

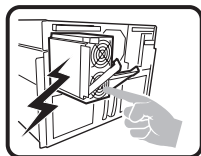

La fuente de alimentación de este producto no contiene piezas que puedan ser reparadas por el usuario. Puede que haya más de una fuente de alimentación en este producto. Para las reparaciones, consulte sólo con el personal cualificado.

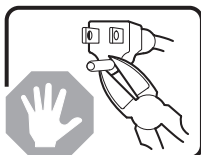

No intente modificar ni utilizar el cable de alimentación de CA suministrado si no es del tipo exacto requerido. Un producto puede estar equipado con más de un cable de alimentación de CA.

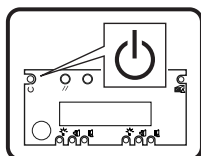

El botón de alimentación del sistema no desactiva toda la alimentación de CA del sistema. Para eliminar toda la alimentación de CA del sistema, deberá desenchufar todos los cables de alimentación de CA del enchufe de pared o de la fuente de alimentación.



Para evitar lesiones causadas por descargas eléctricas y mecánicas, únicamente puede retirar las cubiertas de las carcasas el personal técnico cualificado.

PASOS DE SEGURIDAD: Siempre que retire las cubiertas de las carcasas para acceder al interior del sistema, siga las instrucciones que se especifican a continuación:

1. Desactive todos los dispositivos periféricos conectados al sistema.
2. Pulse el botón de alimentación para desactivar el sistema.
3. Desenchufe todos los cables de alimentación de CA del sistema o de los enchufes de pared.
4. Etiquete y desconecte todas las líneas de telecomunicaciones y todos los cables conectados a los puertos o conectores de E/S de la parte posterior del sistema.
5. Para contar con cierto grado de protección contra descargas electrostáticas (ESD), utilice un brazalete antiestático conectado a la toma de tierra del sistema (cualquier superficie de metal que no esté pintada) al manipular sus componentes.
6. No utilice el sistema sin las cubiertas de la carcasa.

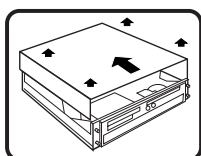

Una vez que haya completado los cinco pasos de SEGURIDAD, podrá retirar las cubiertas del sistema. Para ello:

1. Retire y guarde todos los tornillos de las cubiertas.
2. Retire las cubiertas.

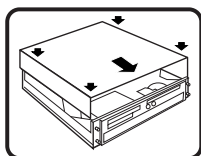

Para obtener una ventilación y un flujo de aire adecuados, reinstale siempre las cubiertas de la carcasa antes de encender el sistema. Si utiliza el sistema sin las cubiertas en su lugar, puede que se dañen algunas piezas del sistema. Para instalar las cubiertas:

1. Asegúrese primero de no haber dejado piezas o herramientas sueltas en el sistema.
2. Compruebe que los cables, tarjetas adicionales y demás componentes están correctamente instalados.
3. Fije las cubiertas a la carcasa con los tornillos que ha retirado anteriormente y apriételos firmemente.
4. Conecte todos los cables externos y los cables de alimentación de CA al sistema.

continuación

Advertencia: Español (continuación)

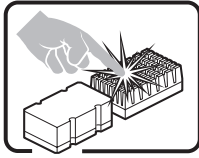

Puede que el microprocesador y el disipador de calor se recalienten si se ha estado ejecutando el sistema. Asimismo, puede que algunas tarjetas o piezas de la carcasa tengan patillas o bordes afilados. Los contactos deberán realizarse cuidadosamente. Puede que sea conveniente llevar guantes de protección.

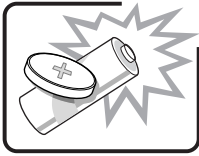

Existe peligro de explosión si la batería se sustituye incorrectamente. Sustitúyala sólo por el mismo tipo o uno equivalente recomendado por el fabricante del equipo. Deseche las baterías usadas según las instrucciones del fabricante.

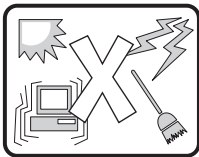

El sistema está diseñado para que funcione en un entorno de oficina típico. Elija un emplazamiento:

- Limpio y libre de partículas de transportadas por aire (aparte del polvo normal de la habitación).
 - Bien ventilado y alejado de las fuentes de calor, incluida la luz del sol directa.
 - Alejado de las fuentes de vibración o de los golpes físicos.
 - Aislado de campos electromagnéticos fuertes producidos por dispositivos eléctricos.
 - Protegido, si se encuentra en regiones susceptibles de tormentas eléctricas. Se recomienda que enchufe el sistema a un supresor de sobretensiones y desconecte las líneas de telecomunicaciones al módem durante una tormenta eléctrica.
 - Que tenga un enchufe de pared correctamente conectado a tierra.
 - Con suficiente espacio para acceder a los cables de la fuente de alimentación, ya que éstos sirven como desconector de alimentación principal del sistema.
-

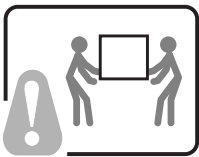

Los servidores pueden ser demasiado pesados para que una sola persona los levante o los mueva de forma segura.

Dependiendo del servidor, utilice dos personas o una ayuda mecánica para levantar o mover el servidor.

B. Electromagnetic Compatibility

This section documents miscellaneous points that should be observed to ensure the proper and safe use of this product worldwide.

The terminology in this section relates to a variety of international EMC standards.

B.1 USA and Canada Specific

This equipment has been tested and found to comply with the limits for a Class A digital device, pursuant to Part 15 of the FCC rules. These limits are designed to provide reasonable protection against harmful interference when the equipment is operated in a commercial environment. This equipment generates, uses and can radiate radio frequency energy and, if not installed and used in accordance with the instruction manual, may cause harmful interference to radio communications. Operation of this equipment in a residential area is likely to cause harmful interference in which case the user will be required to correct the interference at their own expense.

B.2 Installation of Signalling Cards

In order to meet the requirements of the EMC regulations in some installations where cable lengths exceed three metres it may be necessary to use screened cables.

C. List of Part Numbers

Spare parts for the SIU520 and SG430 are listed below:

Table C-1. Part Number Table

Part Number	Description
	Signalling Card
	PSU Module - AC
	PSU Module - DC
	Dual V.11(V.35) to Dual DB15 Cable
	H.100 Ribbon Cable 3 Drop
	RJ45 to DB9 Cable